

Art that
FIGHTS
fire

Technical Data Sheet
BRD - EI₂60

meverin[®]
F I R E D O O R S

EN FF € EI₂ 60
MAGNUM BRD
LARGE SWING DOOR
1-2 LEAVES



TECHNICAL FEATURES

Frame

Combination of a pair of sheet metal profiles made to measure designed to support significant radial loads and designed for fixing by means of dowels (not included) to the load-bearing structure in masonry or insulated and protected metal structure.

Leaf

Single bloc leaf made of press-folded panels in zinc-plated steel sheet with programmed deformability coupled mechanically, where the size requires it. No Sill. **New** MEV FIRUX[®] internal insulation pack (patented) resistant to high temperatures.

FIRUX[®] type intumescent fire seal

Placed on the vertical sides of the frame, on the lower and upper crosspieces of the leaves and in correspondence with the meeting stile.

Cold Smoke Gaskets Sa (optional)

NEW: Cold Smoke Gaskets Sa placed on the profile of the frame (provided on the rebate in the case of two leaves; applied on the perimeter of the frame in the case of a pedestrian door).

NEW: There is the possibility of installing the Sa KIT, as an integration, even at a later time.

Handle

Accident-prevention handle made in stainless steel with double lever with return spring. Handle height = 1050 mm.

Self-latching lock

Primary (mobile) leaf with lock complete with passing cylinder.

Secondary (fixed) leaf with "self-latching" lock for leaf overhead self-latching.

Operation (self-closing)

Closing by means of a large hydraulic door closer; adjustment of the opening effort, the closing speed and the latching speed. For larger dimensions, additional RETURN SPRING hinge with adequate force to strengthen door closer. **Automatic closing**, by means of the aforementioned devices, is guaranteed for a maximum opening of 179°.

Pedestrian door (optional)

NEW: Possibility of inserting a pedestrian door

	Door dimensions			Pedestrian passage dimensions	
	LT (1 leaf)	LT (2 leaves)	HT	LNp	HNp
Pedestrian door	1490	2812	2290	850	2000
without threshold	1780	3364	2290	1140	2000

The measurements are expressed in mm.

For lower LTs ask for feasibility.

If the HT height is lower than the measurements listed above, the height of the pedestrian door is reduced (HNp)

Hinges (patented)

2 for each leaf (depending on the size of the door also 3 / leaf), hardened to support heavy radial loads.

Compulsory accessories for each leaf

- 1 door closer and 1 RETURN SPRING hinge for large dimensions.
- 1 door closer regulator for the correct closing sequence of the leaves for double leaf doors.

Applications

- Surface mounted on solid and load-bearing masonry or reinforced concrete wall.
- Lintel mounted or mounted on an insulated structure finished with plasterboard.

Finish

The doors are made of zinc-plated sheet metal and finished with an ecological primer paint, of industrial type, with high quality epoxy resins, which guarantee protection against corrosion from a vast range of aggressive agents, acid and non-acid, in environments not directly exposed to the outdoor natural atmosphere. Standard color RAL 7035. The full range of RAL and NCS is available on order.

NEW: execution in AISI 304 o 316 stainless steel (excluding accessories inside the casings: hinges, coil spring, etc).

Identification plate

Applied on the shell handle with the appropriate CE mark and with personalized polychrome CARD with identification data.

Documentation provided (CE marking)

Composed by:

- DoP declaration of performance
- declaration of conformity with machinery directive
- installation, use and maintenance manual
- installation instructions

EI₂ 60 LEAF weight and thickness

- Average nominal weight 51 kg/m² wall opening
- Nominal thickness 100 mm
- Average nominal weight 56 kg/m² wall opening
- Nominal thickness 120 mm

EI₂ 60 field of application with CE marking

	BRD 1 leaf EI ₂ 60		BRD 2 leaves EI ₂ 60	
	LT	HT	LT	HT
Maximum dimensions	3337 mm	3347 mm	5940 mm	4237 mm
Maximum surface	9,17 mq		22,02 mq	
Decreasing dimensions	1458 mm	2117 mm	1458 mm	2117 mm

EN FF CE EI₂ 60 MAGNUM BRD LARGE SWING DOOR 1-2 LEAVES

1 LEAF VERSION - CE MARKED - COMPLYING WITH EN 16034 - EN 13241

Also available in stainless steel

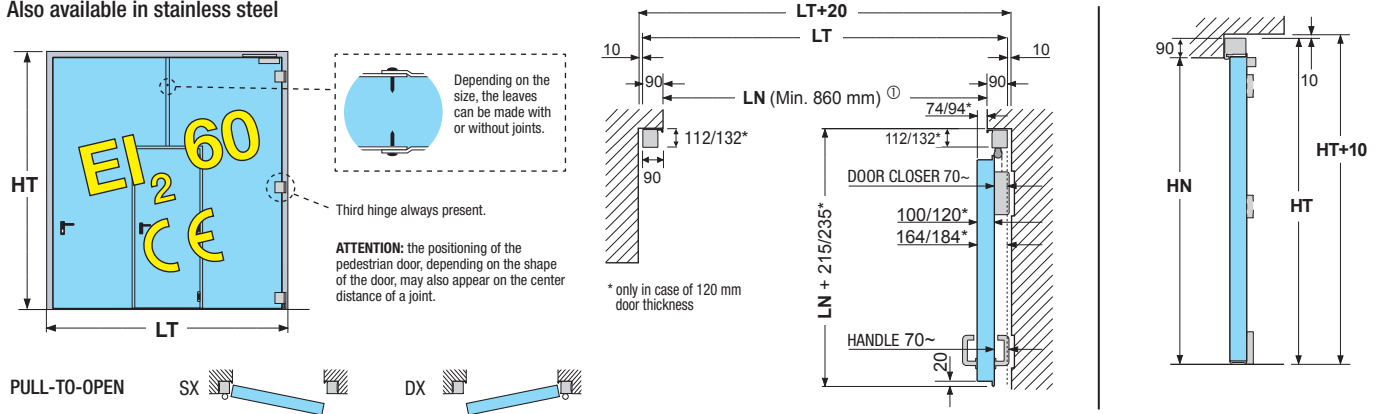

RECESSED MOUNTED *

SIDE DOWELS

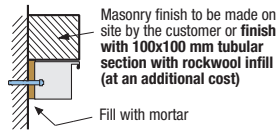

SURFACE MOUNTED OR FLUSH-MOUNTED *

CONTINUOUS ANGULAR SECTION 1/2 DOWELS

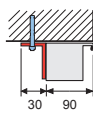

FRONT DOWELS

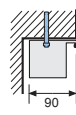

- MOUNTED ON MASONRY OR ON A REINFORCED CONCRETE WALL
- MOUNTED ON METAL LOAD-BEARING AND PROTECTED STRUCTURE

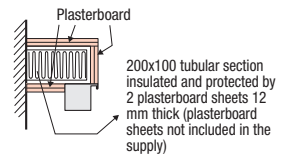

2 LEAVES VERSION - CE MARKED - COMPLYING WITH EN 16034 - EN 13241

Also available in stainless steel

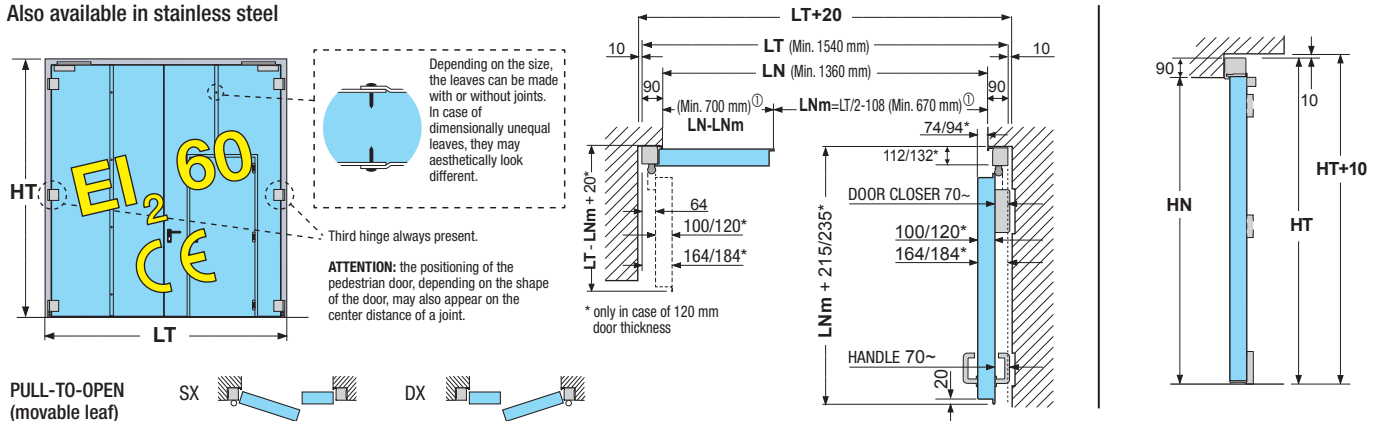

RECESSED MOUNTED *

SIDE DOWELS

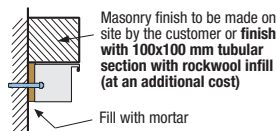

SURFACE MOUNTED OR FLUSH-MOUNTED *

CONTINUOUS ANGULAR SECTION 1/2 DOWELS

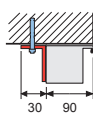

FRONT DOWELS

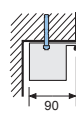

- MOUNTED ON MASONRY OR ON A REINFORCED CONCRETE WALL
- MOUNTED ON METAL LOAD-BEARING AND PROTECTED STRUCTURE

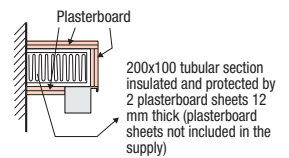

* The basic arrangement provides for lateral fixing with 1/2 dowels.

① Dimension referred to technical feasibility (not from EXAP).

NOTE

- Low traffic flow fire compartmentation element not to be used improperly.
- Assembly to be carried out only by specialized personnel.
- Install in environments not subject to air drafts.
- Install only on perfectly square and level openings suitable to bear high radial loads. It can be installed on load-bearing wall, reinforced concrete, or load-bearing metal structure, insulated and protected.
- Dangerous closure during swinging due to "boom effect".
- Precaution in use and risk analysis are the responsibility of the customer.
- For special cases indicate the spaces available and apply to our technical department.
- Detection system, preferably centralized, to be provided by and at the expense of the customer.
- The leaves and the number of joints may look different.

- Drawings are provided by way of example therefore they are out of scale.
- The dimensions are expressed in millimeters.
- The protocol number will be attributed upon order or production confirmation.
- Meverin reserves the right to make any changes it deems appropriate to this document at any time and without notice.



SEE ACCESSORIES ON PAGE 4 →

EN FF CE EI₂ 60 MAGNUM BRD LARGE SWING DOOR 1-2 LEAVES

ACCESSORIES

- A. SELECTOR
- B. DOOR CLOSER
- D. RETURN SPRING

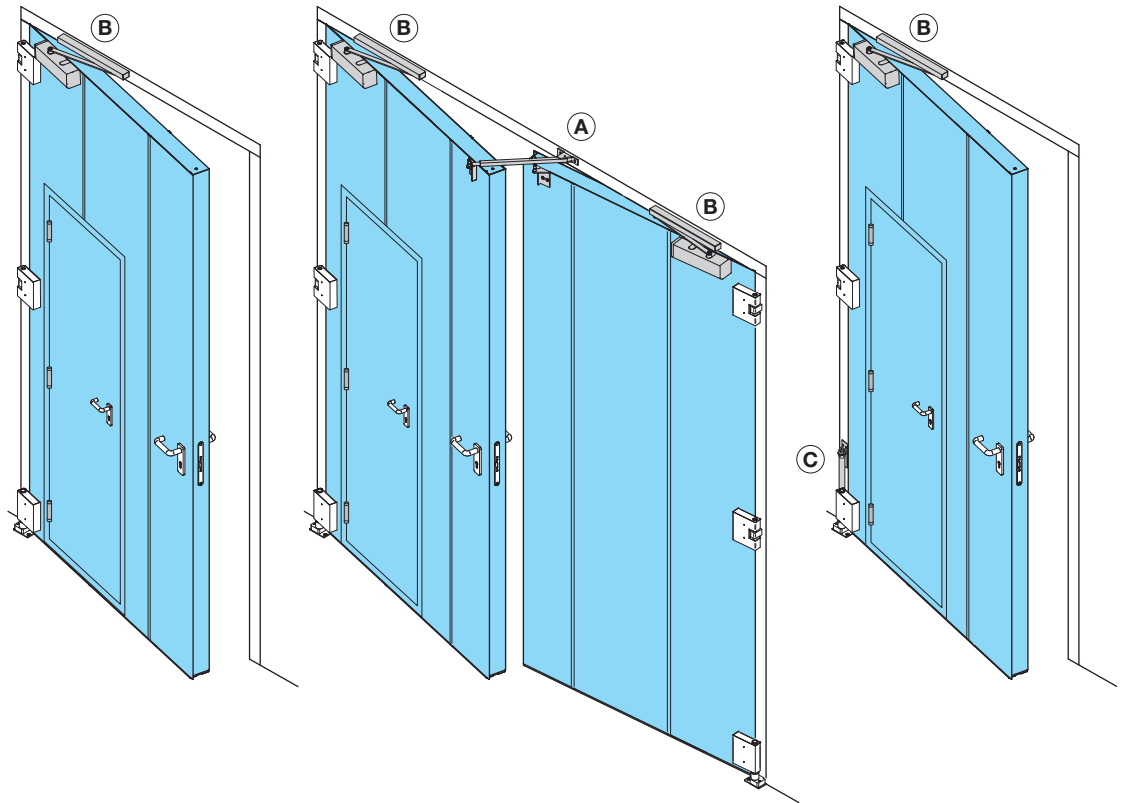

SELECTOR (A)

Front view of closed door with selector.
Accessory provided in the double-leaf door.

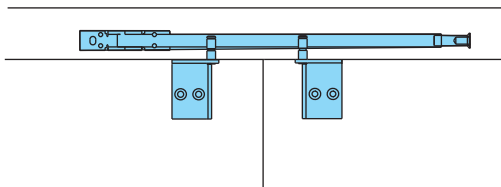

RETURN SPRING (C)

Optional accessory. Maximum opening 179°.

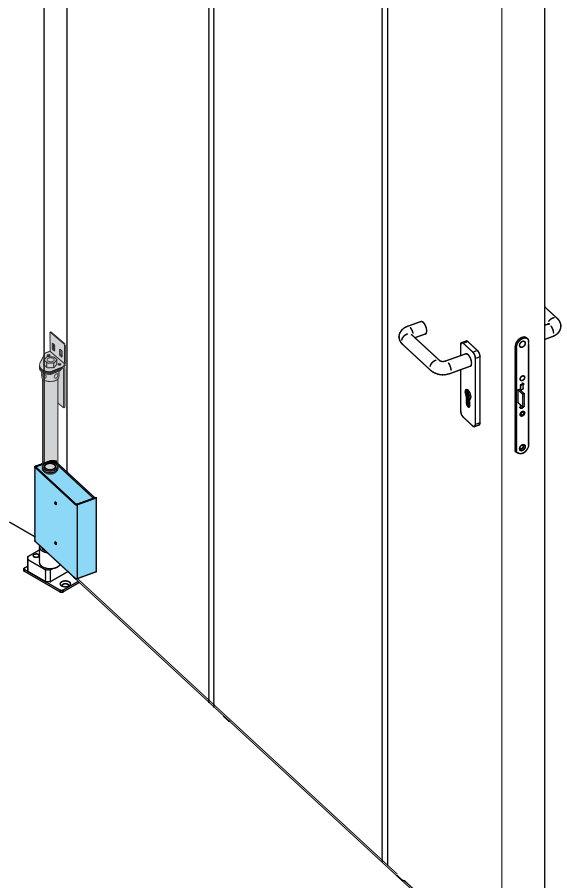

DOOR CLOSER (T)

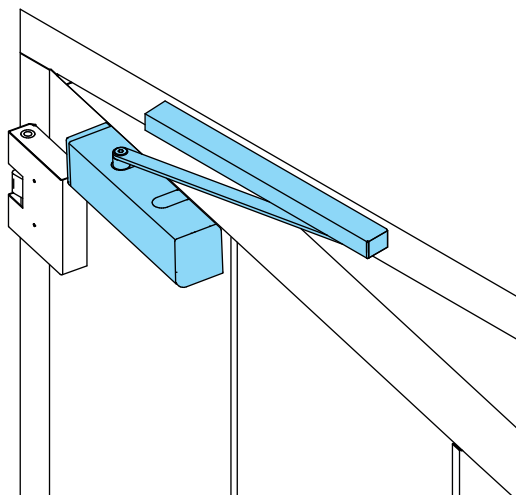

EN FF CE EI₂ 60 MAGNUM BRD LARGE SWING DOOR 1-2 LEAVES

EASY OPENING DEVICE

EXUS PUSH BAR

Standard execution with aluminum bar and black plastic cover.
 Also available in brushed stainless steel.

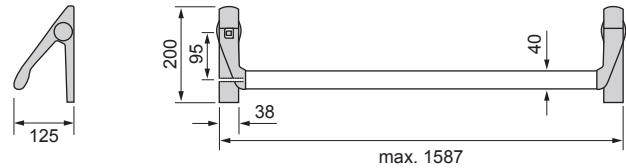

SLASH PUSH BAR

Standard execution with aluminum bar and black plastic cover.
 Also available in brushed stainless steel.

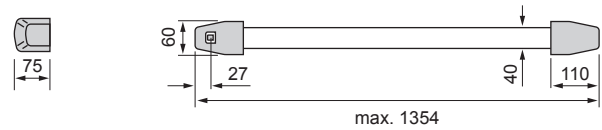

TWIST PUSH BAR

Standard execution with aluminum bar and black plastic cover.

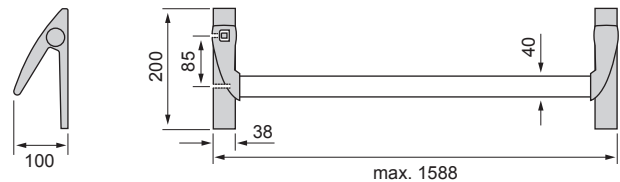

NB: Use of the rotating door on escape routes is at the customer's risk. The easy opening devices are suitable for both mobile or fixed leaves with a maximum size of 2000x3000 mm and a mass up to 300 kg.

CONTROLLED OPENING SYSTEMS

Upon specific request, the rotation door can be supplied with the following controlled opening systems:

Multivoltage electric handle combined with handle or with easy opening device (push handle)

Electromagnet with 300 kg holding force in combination with handle or with easy opening device equipped with microswitch (push handle)